

MEC0141



1/4 direct roll-up gear (max. height: 2.50m)

| Description |
|---|
| Non reversible transmission under load |
| Sealed assembly on bearings in a white powder-coated aluminium casing with top-up greaser |
| Zinc plated output shaft for Ø32mm, Ø34 or square 25x25x1.5 roll-up tube |
| Galvanised steel Ø26 tube handle |

| Specifications | |
|---|--------|
| Gear | 1/4 |
| Operation | Manual |
| Ø60 (aluminium tube) max. single rolling length | 50m |
| Ø32 or Ø34 max. single rolling length | 75m |
| Input torque | 12Nm |
| Output torque | 42Nm |
| Weight | 6.5kg |

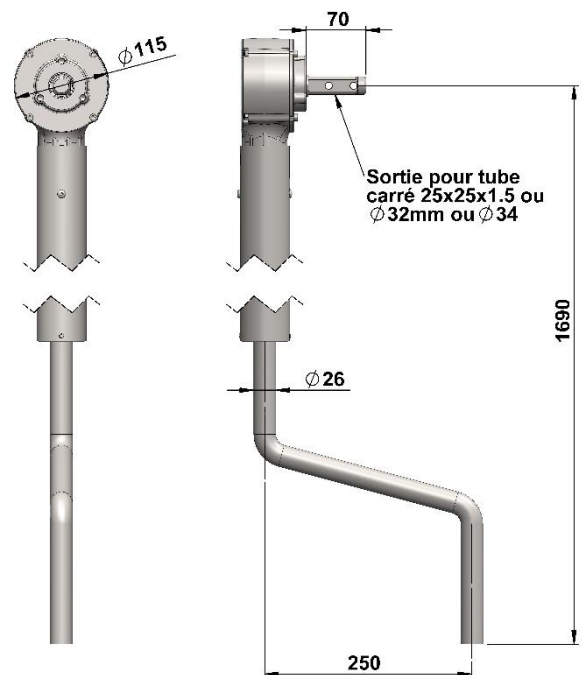

880 rue Léo Baekeland
85290 Mortagne sur Sèvre- France
+33 (0)2 02 51 63 02
contact@anjouautomation.fr

 **Anjou
Automation**
L'innovation est notre culture